



**STACKED  
WOOD**

ENGINEERED HARDWOOD WALL PANELS





2307 FLUTED 5" WALNUT

**FINISH**  
 Fluted 5" Oak UV, Walnut:  
 Varnish 10% Gloss with Antimicrobial Additive  
 Fluted 5" Oak Oil: 100% Natural Oil  
 Fluted 5" Grey, White: Stained plus Varnish  
 10% Gloss with Antimicrobial Additive

**SPECIES**  
 Fluted 5" Grey, Oak, White: White Oak with a MDF Core  
 Fluted 5" Walnut: Walnut with a MDF Core

**WIDTH/LENGTH**  
 Fluted 5": 11.75"/96" or 11.75"/120"  
 \*Available in 8' length or 10' length

**COVERED AREA PER PANEL**  
 Fluted 5" Oak, Walnut, Grey, White:  
 96"/7.8 Sq.ft. or 120"/9.8 Sq.ft.  
 \*Sold per Unit; Ships LTL

**THICKNESS**  
 Fluted 5": 0.51"



2309 FLUTED 5" GREY



2310 FLUTED 5" WHITE

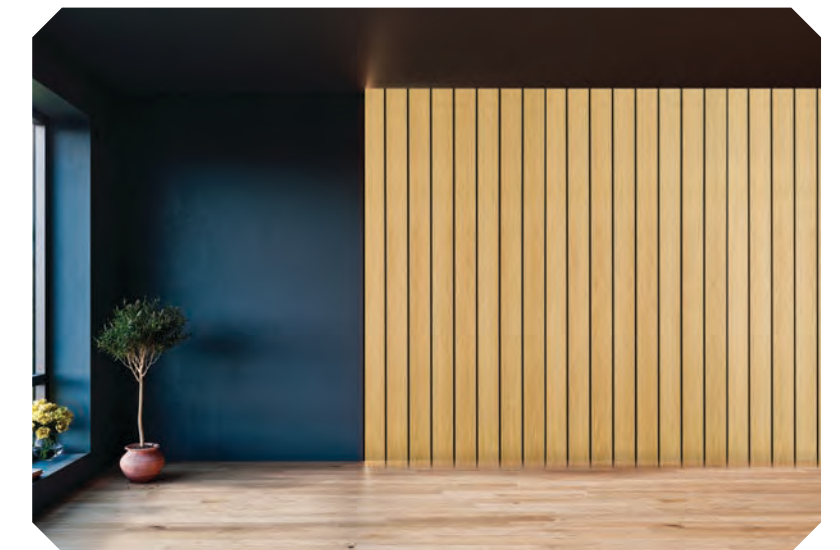

2305 FLUTED 5" OAK UV

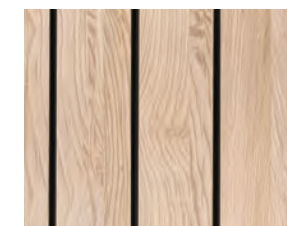

2306 FLUTED 5" OAK OIL

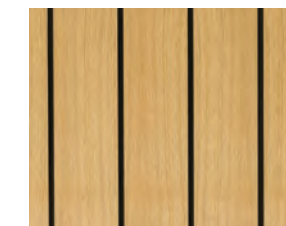

2305 FLUTED 5" OAK UV



2310 FLUTED 5" WHITE



2307 FLUTED 5" WALNUT



2309 FLUTED 5" GREY





2304 FLUTED 2" WHITE



2302 FLUTED 2" WALNUT



2303 FLUTED 2" GREY



2300 FLUTED 2" OAK UV

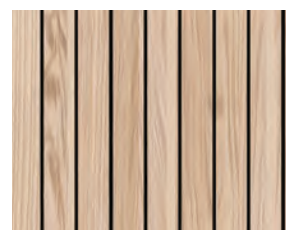

2301 FLUTED 2" OAK OIL



2300 FLUTED 2" OAK UV



2302 FLUTED 2" WALNUT



2304 FLUTED 2" WHITE



2303 FLUTED 2" GREY

**FINISH**

Fluted 2" Oak UV, Walnut:  
Varnish 10% Gloss with Antimicrobial Additive  
Fluted 2" Oak Oil: 100% Natural Oil  
Fluted 2" Grey, White: Stained plus Varnish 10%  
Gloss with Antimicrobial Additive

**SPECIES**

Fluted 2" Grey, Oak, White: White Oak with a MDF Core  
Fluted 2" Walnut: Walnut with a MDF Core

**WIDTH/LENGTH**

Fluted 2": 11.75" / 96" or 11.75" / 120"  
\*Available in 8' length or 10' length

**COVERED AREA PER PANEL**

Fluted 2" Oak, Walnut, Grey, White:  
96" / 7.8 Sq.ft. or 120" / 9.8 Sq.ft.  
\*Sold per Unit; Ships LTL

**THICKNESS**

Fluted 2": 0.51"





2090 FLUTED WALNUT



2036 FLUTED OAK



2097 FLUTED GREY



2098 FLUTED WHITE



2090 FLUTED WALNUT

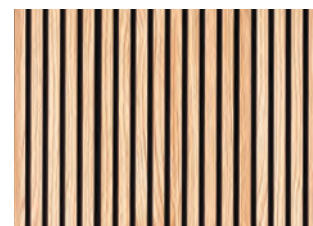

2036 FLUTED OAK

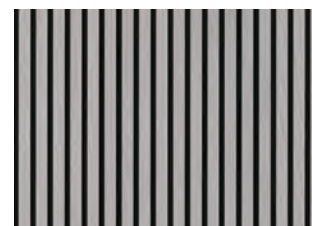

2097 FLUTED GREY

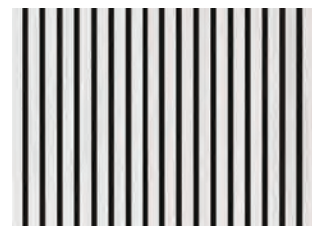

2098 FLUTED WHITE

**FINISH**

Fluted Oak, Walnut: Varnish 10% Gloss with Antimicrobial Additive  
 Fluted Grey, White: Stained plus Varnish 10% Gloss with Antimicrobial Additive

**WIDTH/LENGTH**

Fluted Oak, Walnut, Grey, White: 11.75" / 96" or 11.75" / 120"  
 \*Available in 8' length or 10' length

**SPECIES**

Fluted Oak, Grey, White: White Oak with a MDF Core  
 Fluted Walnut: Walnut with a MDF Core

**THICKNESS**

Fluted : 0.51"

**COVERED AREA PANEL**

Fluted Oak, Walnut, Grey, White: 96" / 7.8 Sq.ft. or 120" / 9.8 Sq.ft.  
 \*Sold per Unit; Ships LTL Only





2095 INTERSQUARE WALNUT



2093 HEX OAK OIL



2092 HEX WALNUT



2096 PEAKS WALNUT

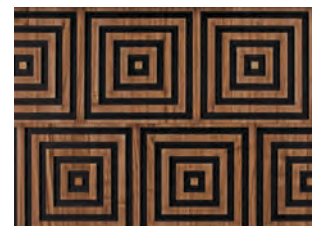

2095 INTERSQUARE WALNUT



2093 HEX OAK OIL

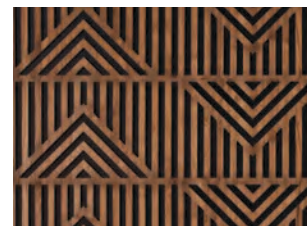

2096 PEAKS WALNUT



2092 HEX WALNUT

FINISH

Hex Walnut, Intersquare Walnut,  
Peaks Walnut: Varnish 10% Gloss  
with Antimicrobial Additive  
Hex Oak Oil: 100% Natural Oil

WIDTH/LENGTH

Hex Oak Oil, Hex Walnut: 11.75"/ 45.9"  
Intersquare Walnut: 15.7"/ 47.2"  
Peaks Walnut: 15.5"/ 47.2"

SPECIES

Hex Walnut, Intersquare Walnut,  
Peaks Walnut: Walnut with a MDF Core  
Hex Oak Oil: White Oak  
with a MDF Core

THICKNESS

Hex Oak Oil, Hex Walnut,  
Intersquare Walnut, Peaks Walnut: 0.51"

COVERED AREA PER CASE

Hex Oak Oil, Hex Walnut: 11.1 Sq.ft.  
Intersquare Walnut: 15.3 Sq.ft.  
Peaks Walnut: 15.27 Sq.ft.





2091 INTERSECT WALNUT

**FINISH**

Amazed (Oak/Walnut),  
Intersect (Oak/Walnut) :  
Varnish 10% Gloss with  
Antimicrobial Additive

**SPECIES**

Amazed Oak, Intersect Oak:  
White Oak with an MDF Core  
Amazed Walnut, Intersect Walnut:  
Walnut with an MDF Core

**COVERED AREA PER CASE**

Amazed (Oak/Walnut): 14.1 Sq.ft.  
Intersect (Oak/Walnut): 15.27 Sq.ft.

**WIDTH/LENGTH**

Amazed (Oak/Walnut): 14.4"/ 47.1"  
Intersect (Oak/Walnut): 15.4"/ 47.6"

**THICKNESS**

Amazed (Oak/Walnut): 0.51"  
Intersect (Oak/Walnut): 0.51"



2031 AMAZED OAK



2094 AMAZED WALNUT



2038 INTERSECT OAK

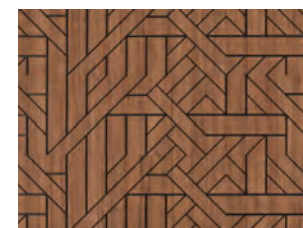

2094 AMAZED WALNUT

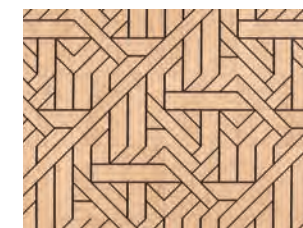

2031 AMAZED OAK

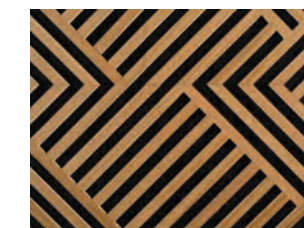

2038 INTERSECT OAK

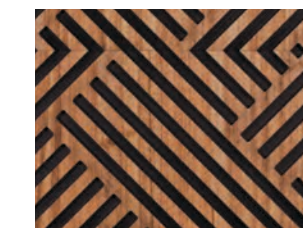

2091 INTERSECT WALNUT



# Midnight Collection



3006 BLACK FLUTED



3007 BLACK FLUTED 2"



3008 BLACK FLUTED 5"



3007 BLACK FLUTED 2"



3001 BLACK HEX



3003 BLACK AMAZED



3002 BLACK INTERSECT

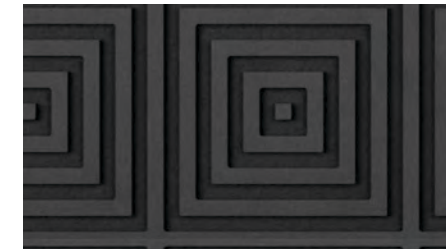

3004 BLACK INTERSQUARE



3005 BLACK PEAKS



3008 BLACK FLUTED 5"

WIDTH/LENGTH  
 Amazed: 14.4" / 47.1"  
 Fluted, Fluted 2", 5":  
 11.75" / 96" or 11.75" / 120"  
 \*Available in 8' length or 10' length  
 Hex: 11.75" / 45.9"  
 Intersect: 15.4" / 47.6"  
 Intersquare: 15.7" / 47.2"  
 Peaks: 15.5" / 47.2"

FINISH  
 Varnish 10% Gloss with  
 Antimicrobial Additive

SPECIES  
 Black MDF with 0.5mm Wood  
 Veneer Backing

THICKNESS  
 0.49"

COVERED AREA PER CASE  
 Amazed: 14.1 Sq.ft.  
 Fluted, Fluted 2", 5":  
 96" / 7.8 Sq.ft. or 120" / 9.8 Sq.ft.  
 \*Sold per Unit; Ships LTL  
 Hex: 11.1 sq.ft.  
 Intersect, Peaks: 15.27 Sq.ft.  
 Intersquare: 15.3 Sq.ft.



# Acoustical Collection - Eco



8003 FLUTED ECO OAK



8005 FLUTED ECO GREY



8003 FLUTED ECO WHITE

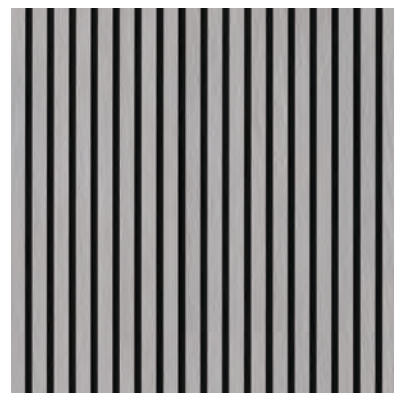

8005 FLUTED ECO GREY

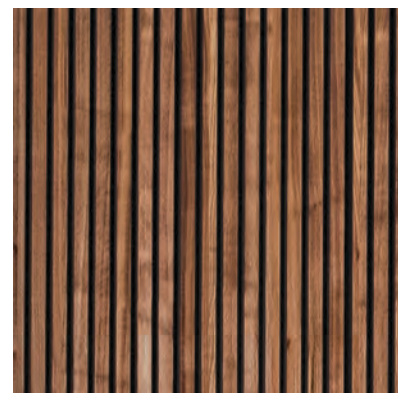

8004 FLUTED ECO WALNUT

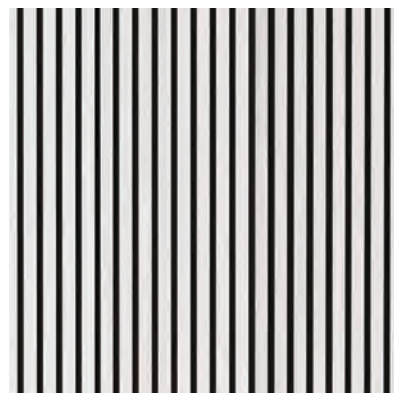

8006 FLUTED ECO WHITE

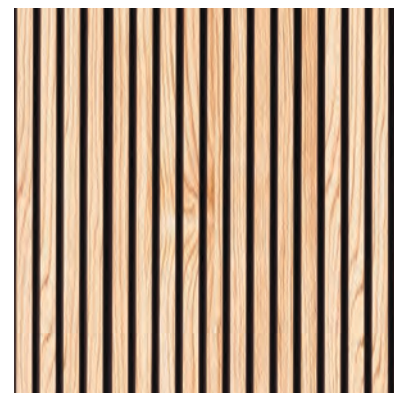

8003 FLUTED ECO OAK

WIDTH/LENGTH  
Fluted Eco: 11.75" / 96"

THICKNESS  
Fluted Eco: 0.87"

COVERED AREA PER PANEL  
Fluted Eco: 7.8 Sq.ft. per panel  
*\*Sold per Unit; Ships LTL*

FINISH  
Fluted Eco Grey, Oak, Walnut, White:  
Varnish 10% Gloss with Antimicrobial  
Additive

SPECIES  
Fluted Eco Oak, Grey, White: White Oak / Wood Veneer with a MDF Core with a Felt Backing.  
Fluted Eco Walnut: Walnut / Wood Veneer with a MDF Core with a Felt Backing.

NRC AND FIRE RATING  
Fluted Eco: NRC 0.54 up to 0.90  
*\*Depending on Mounting Method*  
Class A Fire



# Acoustical Collection



8000 ACOUSTICAL HEX



8002 ACOUSTICAL ARBOUR



8001.2 ACOUSTICAL FLUTED

## WIDTH/LENGTH

Acoustical Arbour, Hex: 12.8" / 48"  
Acoustical Fluted: 12.8" / 96"

## FINISH

Acoustical Arbour, Fluted, Hex:  
Varnish 10% Gloss with Antimicrobial Additive

## THICKNESS

Acoustical Arbour, Hex: 0.92"  
Acoustical Fluted: 1.14"

## COVERED AREA PER CASE

Acoustical Arbour, Hex: 8.6 Sq.ft.  
Acoustical Fluted: 8.5 Sq.ft. per panel  
*\*Sold per Unit; Ships LTL*

## SPECIES

Acoustical Arbour, Hex: White Oak with a MDF Core  
Backing Stone Wool with MDF Frame  
Acoustical Fluted: White Oak with Fire  
Treated MDF Core backing Stone Wool with  
MDF Frame

## NRC AND FIRE RATING

Acoustical Arbour, Fluted, Hex:  
NRC 0.60 & Class A Fire



8000 ACOUSTICAL HEX

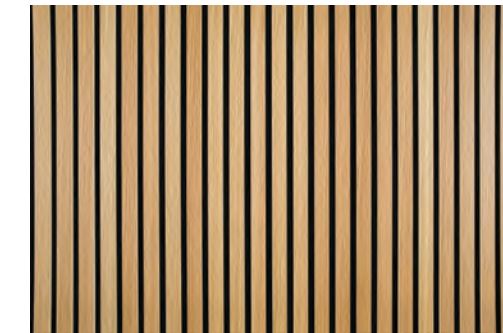

8001.2 ACOUSTICAL FLUTED



8002 ACOUSTICAL ARBOUR





8007 ACOUSTICAL FLUTED WALNUT

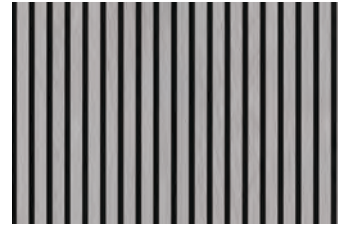

8008 ACOUSTICAL FLUTED GREY

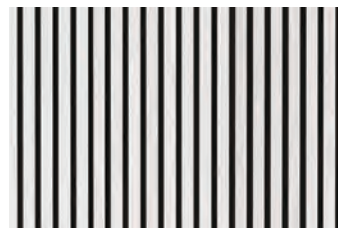

8009 ACOUSTICAL FLUTED WHITE



8010 ACOUSTICAL HEX WALNUT



8011 ACOUSTICAL ARBOUR WALNUT



8007 ACOUSTICAL FLUTED WALNUT



8010 ACOUSTICAL HEX WALNUT

**WIDTH/LENGTH**

Acoustical Arbour, Hex Walnut: 12.8" / 48"  
Acoustical Fluted Grey, Walnut, White:  
12.8" / 96"

**THICKNESS**

Acoustical Arbour, Fluted, Hex: 1.14"  
Acoustical Fluted Grey, Walnut, White: 1.14"

**FINISH**

Acoustical Arbour, Fluted, Hex Walnut:  
Varnish 10% Gloss with Antimicrobial Additive  
Acoustical Fluted Grey, White: Stained plus  
Varnish 10% Gloss with Antimicrobial Additive

**NRC AND FIRE RATING**

Acoustical Arbour, Fluted, Hex Walnut:  
Acoustical Fluted Grey, Walnut, White:  
NRC 0.60 & Class A Fire

**COVERED AREA PER CASE**

Acoustical Arbour, Hex Walnut: 8.6 Sq.ft.  
Acoustical Fluted: 8.5 Sq.ft. per Panel  
*\*Sold per Unit; Ships LTL*

**SPECIES**

Acoustical Arbour Walnut, Hex Walnut:  
Walnut with Fire Treated MDF Core  
Backing Stone Wool with MDF Frame  
Acoustical Fluted Grey, White:  
White Oak with Fire Treated MDF Core  
Backing Stone Wool with MDF Frame

*\*Acoustical Hex and Arbour can be ordered as a 'Standard-Custom'  
in Grey and White for a minimum of 500 Sq. ft.*



# Paintable Collection



2086 PEAKS PAINTABLE



2084 AMAZED PAINTABLE

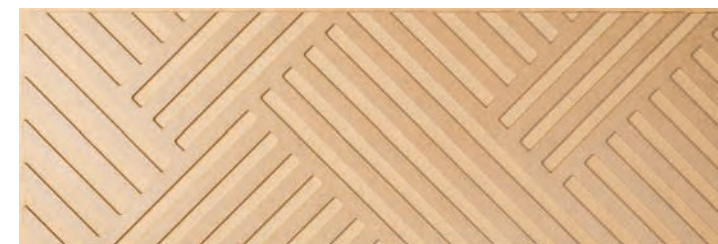

2082 INTERSECT PAINTABLE



2081 HEX PAINTABLE



2080 FLUTED PAINTABLE



2085 INTERSQUARE PAINTABLE

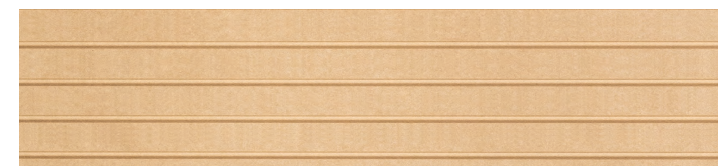

2087 FLUTED 2" PAINTABLE



2088 FLUTED 5" PAINTABLE

The Paintable collection is made out of nude 12 mm MDF. The panels are unfinished and intended to be painted to your desired color. \* It is recommended to paint the panel with acrylic primer and paint to seal. *Consult with your local paint store for specific product information.*

## WIDTH/LENGTH

Amazed: 14.4" / 47.1"  
 Fluted (2"/5"): 11.75" / 96"  
 Hex: 11.75" / 45.9"  
 Intersect: 15.4" / 47.6"  
 Intersquare: 15.7" / 47.2"  
 Peaks: 15.5" / 47.2"

## THICKNESS

Amazed, Fluted (2"/5"), Hex, Intersect, Intersquare, Peaks: 0.48"

## SPECIES

Amazed, Fluted (2"/5"), Hex, Intersect, Intersquare, Peaks: 100% MDF with a Laminate Backer

## FINISH

Amazed, Fluted (2"/5"), Hex, Intersect, Intersquare, Peaks: Unfinished

## COVERED AREA PER CASE

Amazed: 14.1 Sq.ft.  
 Fluted (2"/5"): 7.8 Sq.ft. per panel  
*\*Sold per Unit; Ships LTL*  
 Hex: 11.1 Sq.ft.  
 Intersect, Peaks: 15.27 Sq.ft.  
 Intersquare: 15.3 Sq.ft.



# Cork Collection



8100 CORCHO NATURAL



8102 CORCHO DARK GRAY



8101 CORCHO WHITE



8202 CORTICA DARK GRAY



8100 CORCHO NATURAL



8101 CORCHO WHITE



8200 CORTICA NATURAL



8202 CORTICA DARK GRAY



8201 CORTICA WHITE

## WIDTH/LENGTH

Corcho (Natural/ White/ Dark Gray):  
12" / 48"

Cortica (Natural/ White/ Dark Gray):  
12" / 48"

## FINISH

Corcho Natural, Cortica Natural:  
Matte Varnish

Corcho (White/ Dark Gray),  
Cortica (White/ Dark Gray):  
2 Coats of Acrylic Paint

## SPECIES

Corcho, Cortica:  
Cork with a MDF Core

## THICKNESS

0.39"

COVERED AREA PER CASE  
Corcho, Cortica: 20 Sq.ft.





2033 ZIG ZAG

**FINISH**  
 Cubed, Incline, Slant, Vertex, Zig Zag:  
 Varnish 10% Gloss with Antimicrobial Additive

**WIDTH/LENGTH**  
 Cubed: 17.14" / 45.15"  
 Incline and Vertex: 24" / 24"  
 Slant: 23.5" / 23.5"  
 Zig Zag: 16.05" / 41.69"

**SPECIES**  
 Cubed, Slant, Vertex: White Oak with a MDF Core  
 Incline, Zig Zag: Walnut with a MDF Core

**THICKNESS**  
 Cubed, Incline, Slant, Vertex, Zig Zag: 0.28"

**COVERED AREA PER CASE**  
 Cubed: 21.48 Sq.ft.  
 Incline: 24 Sq.ft.  
 Slant: 15.3 Sq.ft.  
 Vertex: 24 Sq.ft.  
 Zig Zag: 18.6 Sq.ft.



2034 VERTEX



2035 SLANT



2037 INCLINE



2032 CUBED

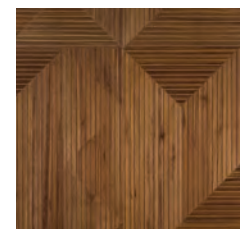

2037 INCLINE

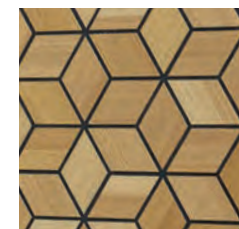

2032 CUBED

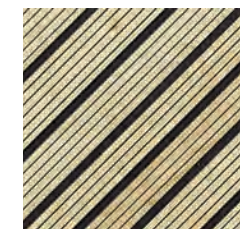

2035 SLANT



2034 VERTEX



2033 ZIG ZAG





4422 RHOMBUS PLAY



8844 LOZENGE



3313 POLYGON

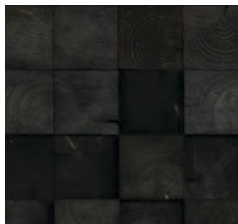

0929 QUADRI



4422 RHOMBUS PLAY



8844 LOZENGE



0929 QUADRI



3313 POLYGON

**FINISH**

Lozenge: 100% Natural Oil  
 Polygon: 100% Natural Oil  
 Quadri: 100% Natural Oil  
 Rhombus Play: 100% Natural Oil

**WIDTH/LENGTH**

Lozenge, Polygon, Rhombus Play: 14"/ 48.5"  
 Quadri: 11.25"/ 56.25"

**SPECIES**

Lozenge: White Oak  
 Polygon: White Oak  
 Quadri: Barn Wood  
 Rhombus Play: Poplar

**THICKNESS VARIATION**

Lozenge, Polygon, Rhombus Play: 0.26" and 0.47"  
 Quadri: 0.71", 0.91" and 1.11"

**COVERED AREA PER CASE**

Lozenge: 14.1 Sq.ft.  
 Polygon, Rhombus Play: 14.1 Sq.ft.  
 Quadri: 8.8 Sq.ft.



WIDTH/LENGTH  
13.44"/53.75"

COVERED AREA PER CASE  
20 Sq.ft.

THICKNESS  
0.59"

FINISH  
Oak Weave: 100% Natural Oil  
Walnut Weave: 100% Natural Oil

SPECIES  
Oak Weave: White Oak  
Walnut Weave: Walnut

2001 OAK WEAVE



2002 WALNUT WEAVE

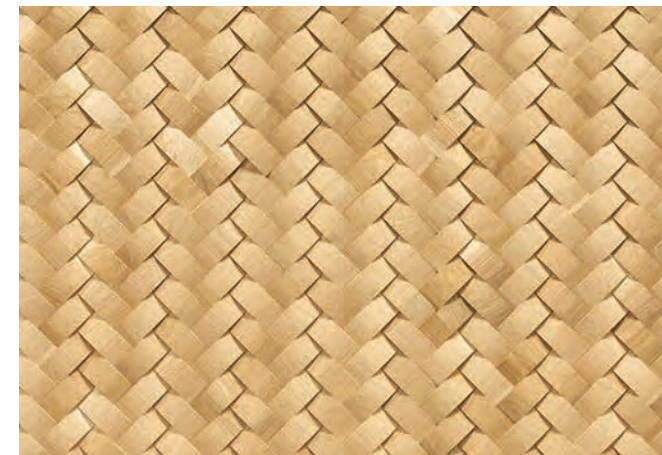

2001 OAK WEAVE



2002 WALNUT WEAVE



Our Teak Natural, Cloud, Coco RC are FSC-Certified, composed entirely of recycled wood from old homes and buildings from Indonesia. Through FSC-certification, we demonstrate our commitment to the environment.



6001 TEAK CLASSIC RP



6003 TEAK CLOUD RC



6002 TEAK NATURAL RC

**FINISH**  
 Teak Classic RP: Unfinished  
 Teak Natural RC: Unfinished  
 Teak Cloud, Coco RC: Pre-Stained

**SPECIES**  
 Teak Classic RP: Recycled Teak  
 Teak Natural RC: Recycled Teak  
 Teak Cloud, Coco RC: Recycled Teak

**COVERED AREA PER CASE**  
 Teak Classic RP: 10.8 Sq.ft.  
 Teak Natural RC: 10.8 Sq.ft.  
 Teak Cloud, Coco RC: 10.8 Sq.ft.

**WIDTH/LENGTH**  
 Teak Classic RP: 8"/19.5"  
 Teak Natural, Cloud, Coco RC: 8"/19.5"

**THICKNESS VARIATION**  
 Teak Classic RP: 0.25" and 0.85"  
 Teak Natural, Cloud, Coco RC: 0.25" and 0.85"



6001 TEAK CLASSIC RP



6002 TEAK NATURAL RC

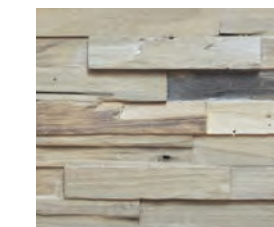

6003 TEAK CLOUD RC



6004 TEAK COCO RC





**FINISH**

Rootwood Beach, Dyed: Pre-Stained  
 Rootwood Natural: Unfinished  
 Branchwood Natural: Unfinished

**WIDTH/LENGTH**

Rootwood Beach, Dyed, Natural: 9"/19.5"  
 Branchwood Natural: 8"/19.5"

**SPECIES**

Rootwood Beach, Dyed, Natural:  
 Repurposed Teak Root Wood  
 Branchwood Natural: Repurposed Teak Branch Wood

**THICKNESS VARIATION**

Rootwood Beach, Dyed, Natural: 0.25" and 0.85"  
 Branchwood Natural: 0.25" and 0.85"

**COVERED AREA PER CASE**

Rootwood Beach, Dyed, Natural: 11 Sq.ft.  
 Branchwood Natural: 10.8 Sq.ft.



6005 ROOTWOOD NATURAL

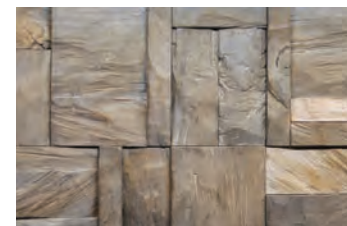

6007 ROOTWOOD BEACH



6006 ROOTWOOD DYED

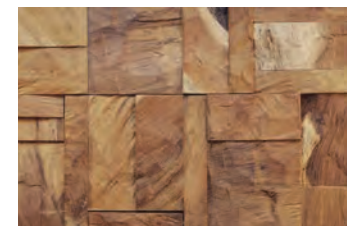

6005 ROOTWOOD NATURAL



6008 BRANCHWOOD NATURAL





6009 HEXACOMB NATURAL



6013 PROSPERITY COCO



6012 PROSPERITY NATURAL

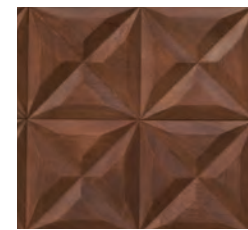

6013 PROSPERITY COCO



6009 HEXACOMB NATURAL



6010 HEXACOMB COCO

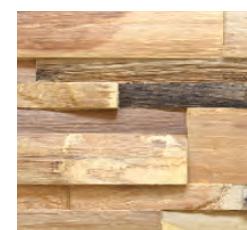

6011 BARKWOOD NATURAL

**FINISH**

Hexacomb Natural: Unfinished  
 Hexacomb Coco: Pre-Stained  
 Barkwood Natural: Unfinished  
 Prosperity Natural: Unfinished  
 Prosperity Coco: Pre-Stained

**WIDTH/LENGTH**

Hexacomb: 8.19"/ 21.25"  
 Barkwood: 7.87"/ 19.69"  
 Prosperity: 14.56"/ 21.87"

**SPECIES**

Hexacomb: Teak Root Wood  
 Barkwood: Teak Bark Wood  
 Prosperity: Teak Root Wood

**THICKNESS VARIATION**

Hexacomb, Barkwood, Prosperity:  
 0.37" and 0.87"

**COVERED AREA PER CASE**

Hexacomb: 10.8 Sq.ft.  
 Barkwood: 10.8 Sq.ft.  
 Prosperity: 11.0 Sq.ft.



WIDTH/LENGTH

Cellar: 14"/40"  
Heraldry: 16.5"/59.5"  
Origin: 18"/68"  
Washed: 18"/68"

THICKNESS VARIATION

Cellar: 0.39" and 0.43"  
Heraldry: 0.43" and 0.51"  
Origin: 0.47" and 0.55"  
Washed: 0.47" and 0.55"

COVERED AREA PER CASE

Cellar: 15.6 Sq.ft.  
Heraldry: 27.2 Sq.ft.  
Origin: 25.5 Sq.ft.  
Washed: 25.5 Sq.ft.

FINISH

Cellar: Unfinished  
Heraldry: Unfinished  
Origin: Unfinished  
Washed: Wire Brushed and Stained

SPECIES

Barn Wood



0903 CELLAR



2022 WASHED



0101 HERALDRY



2021 ORIGIN



0903 CELLAR



0101 HERALDRY



2022 WASHED



2021 ORIGIN



WIDTH/LENGTH  
14"/57"

THICKNESS VARIATION  
0.28" and 0.35"

COVERED AREA PER CASE  
22 Sq.ft.

FINISH  
Antiqued: 100% Natural Oil  
Juglans: Varnish 10% Gloss  
with Antimicrobial Additive

SPECIES  
Antiqued: White Oak  
Juglans: Walnut

2012 JUGLANS



2012 JUGLANS



4796 ANTIQUED

4796 ANTIQUED



O429 LOBO



OIII ADVENT

WIDTH/LENGTH  
14"/44"

THICKNESS VARIATION  
0.33" and 0.39"

SPECIES  
Maple

FINISH  
Varnish 10% Gloss with  
Antimicrobial Additive

COVERED AREA PER CASE  
17 Sq.ft.



O429 LOBO

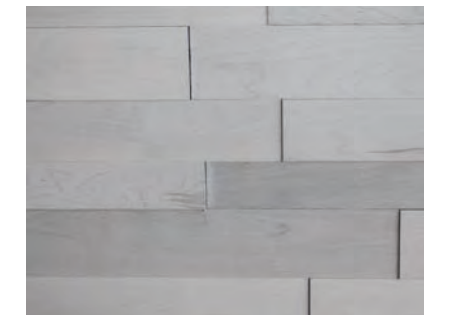

OIII ADVENT





2590 ANDOVER

**FINISH**  
 Andover, Beach: 100% Natural Oil  
 Barn: Varnish 10% Gloss with Antimicrobial Additive  
 Natural: Unfinished

**WIDTH/LENGTH**  
 Andover, Barn, Beach: 14" / 47"  
 Natural: 14" / 44"

**SPECIES**  
 Andover, Beach: White Oak  
 Barn: Walnut  
 Natural: Barn Wood

**THICKNESS VARIATION**  
 Andover, Barn, Beach: 0.43" and 0.51"  
 Natural: 0.47" and 0.55"

**COVERED AREA PER CASE**  
 Andover, Barn, Beach: 18.2 Sq.ft.  
 Natural: 17 Sq.ft.



O318 BARN



3812 BEACH



I231 NATURAL

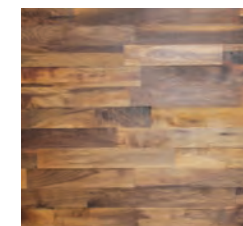

O318 BARN

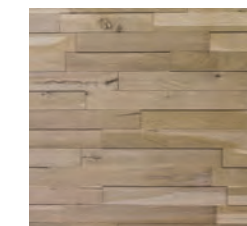

3812 BEACH

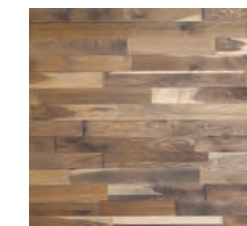

2590 ANDOVER

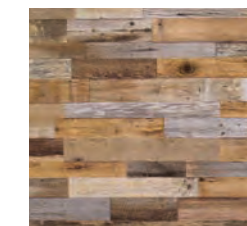

I231 NATURAL



9130 NIAGARA



O310 NANAVUT

WIDTH/LENGTH  
13.5"/53.5"

THICKNESS VARIATION  
0.19", 0.26" and 0.31"

COVERED AREA PER CASE  
25 Sq.ft.

FINISH  
100% Natural Oil

SPECIES  
Nanavut: Red Oak  
Niagara: White Oak  
Yukon: Maple



1012 YUKON

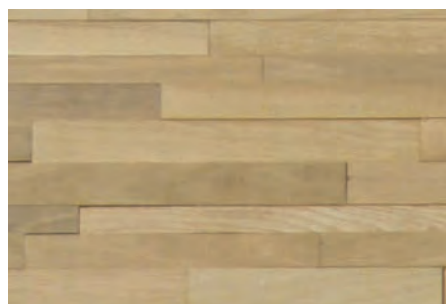

9130 NIAGARA



O310 NANAVUT



1012 YUKON





1223 ALBERTA



1223 ALBERTA



O602 BRITISH COLUMBIA



O530 MANITOBA



O530 MANITOBA



O602 BRITISH COLUMBIA

WIDTH/LENGTH  
12"/ 60"

THICKNESS VARIATION  
0.35" and 0.43"

COVERED AREA PER CASE  
25 Sq.ft.

FINISH  
100% Natural Oil

SPECIES  
Mix of Hardwood Species

*Due to the nature of the product  
as a unique and organic material,  
imperfections and variations in wood grain  
and color may vary from samples.*





1105 PRINCE EDWARD



1105 PRINCE EDWARD

WIDTH/LENGTH  
13.5"/53.5"

THICKNESS VARIATION  
0.19", 0.26" and 0.31"

SPECIES  
Walnut

FINISH  
Varnish 10% Gloss with  
Antimicrobial Additive

COVERED AREA PER CASE  
25 Sq.ft.

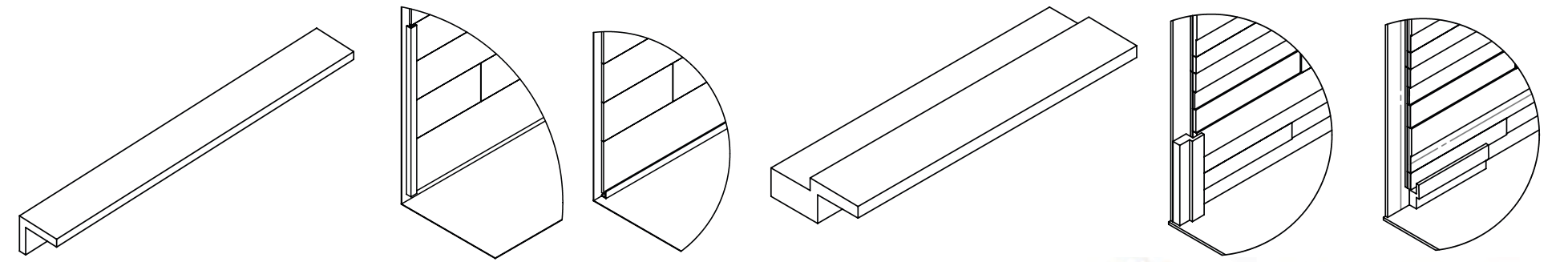

# Trim Pieces

## Corner and Contour Moldings

Design is in the details. You can customize your look by installing our decorative panels wall to wall or with corner or contour molding. Our trim is sold in 90" pieces; availability varies based on species and wall panel. Please contact your sales representative today for more information.







# Customization

## Limitless Design Options

We have extensive experience taking conceptual designs and quickly translating them into prototypes and tangible products. That's a huge advantage for designers and architects. We act as a facilitator, knocking down barriers one by one so nothing stands in the way of your creative process.



CUSTOM BARNWOOD



CUSTOM FLUTED ACOUSTICAL WITH LOGO



CUSTOM WHITE





CUSTOM FLUTED WITH LOGO



CUSTOM HICKORY

# Customization

## We Bring Your Ideas to Life

Products can be personalized or fully customized. Can't find the exact design or finish you want in our collections? When creativity calls, we're there every step of the way. Take advantage of our clever, artistic approaches as we guide you through a fast, personalized development process that takes into account your creative vision.

## Quick Mock-Ups

You need to know your idea will work, and you need to know now. One of the things architects and designers appreciate about working with Stacked Wood is our ability to develop mock-ups in short order, helping streamline your creative process.



CUSTOM VERTICAL



# Tailor Made Process



CHOOSE FROM ITEMS THAT ARE EASILY MADE FOR YOU IN OUR TAILOR MADE SELECTION, IT IS A DIFFERENT WAY TO ORDER STACKED WOOD WALLS.

WE HAVE SHEETS READY TO GO FOR YOUR DESIGN NEEDS.

## Select Your Design

Select one of six design options to start the Tailor Made process.

## Choose Your Wood

Select either Walnut or White Oak as your wood species.

## Select Your Finish

Choose from 10% Varnish finish with an added antimicrobial additive or 100% Natural Oil.

## Ship Time

Once your order is processed your order will be available to ship in five to seven business days.

## DESIGN OPTIONS

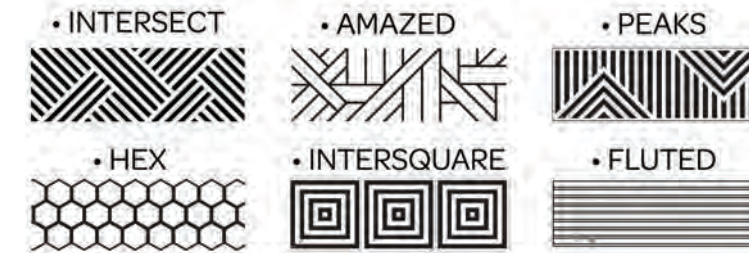

## WOOD OPTIONS



## FINISH OPTIONS



HEX OAK - UV

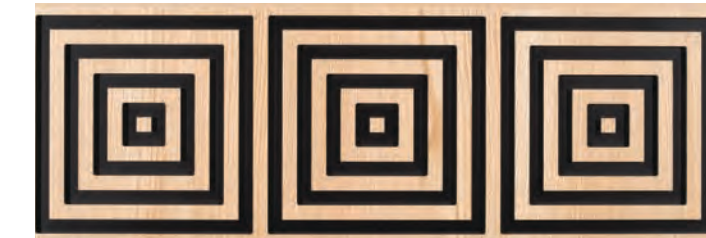

INTERSQUARE OAK - OIL



AMAZED OAK - OIL



FLUTED OAK - OIL



INTERSECT OAK - OIL



# Stacked Wood Ceilings



FLUTED CEILING TILE - 2 OAK & 2 WALNUT TILES

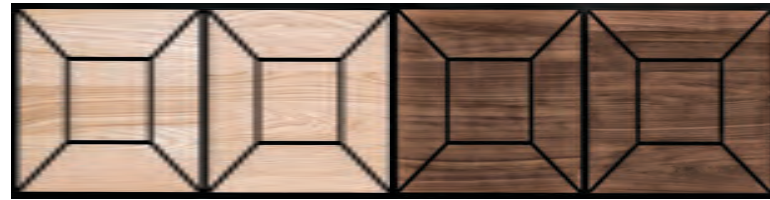

EMERALD CEILING TILE - 2 OAK & 2 WALNUT TILES

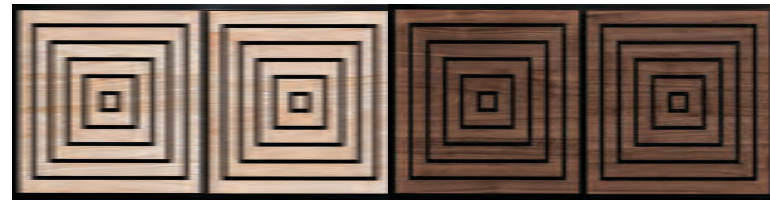

INTERSQUARE CEILING TILE - 2 OAK & 2 WALNUT

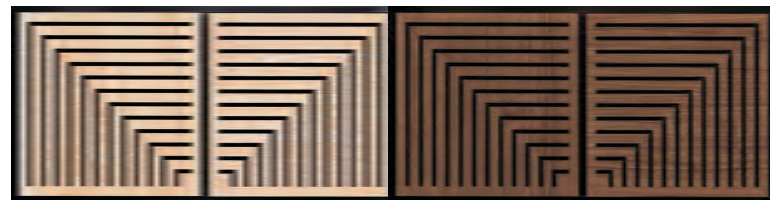

SHIFT OAK TILE - 2 OAK & 2 WALNUT TILES



SLANT CEILING TILE - 2 OAK & 2 WALNUT TILES

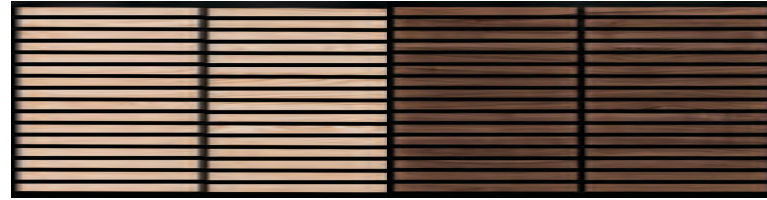

LINEAR CEILING TILE - 2 OAK & 2 WALNUT TILES



AERIAL CEILING PLANKS - OAK



AERIAL CEILING PLANKS - WALNUT

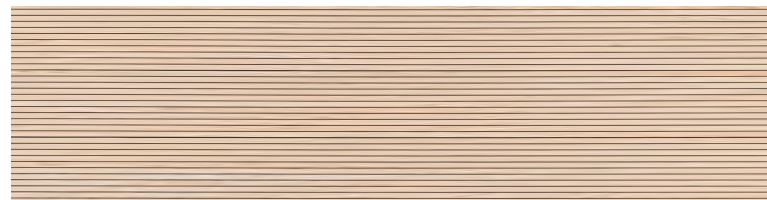

SLEEK CEILING PLANKS - OAK



SLEEK CEILING PLANKS - WALNUT



CEILING TILES AND PLANKS ARE A NEW OUTSTANDING PROGRAM BROUGHT TO THE STACKED WOOD LINE. LOOK FOR THE NEW BROCHURE.

## Select Your Design, Wood, and Profile

Select your tile or plank design in either White Oak or Walnut. If you are selecting a tile choose between 9/16 or 15/16 track profile.

## Acoustical Option

Add a black EcoCore 0.9" thick panel to the back of any Stacked Wood Ceiling Tile or Panel to gain an NRC rating between 0.55-0.65 (depending on mounting method). Made of 100% polyester. Class A Fire rating.

## Contact Your Rep

Reach out to your sales rep to figure out the number of tiles needed, profile, acoustical option and more.























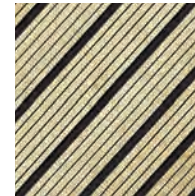
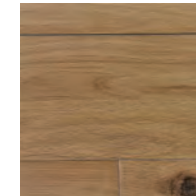

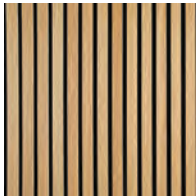
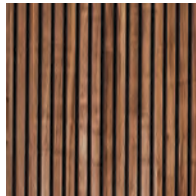
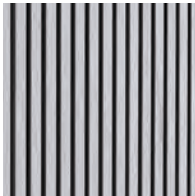



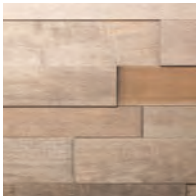

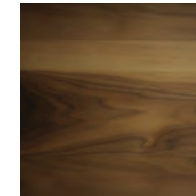



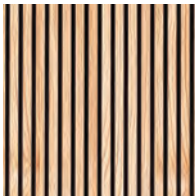

# S U M M A R Y

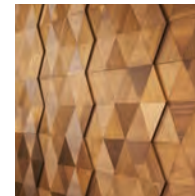
## Experience Samples

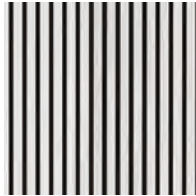
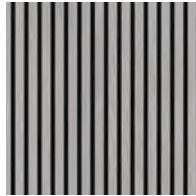
Experience the beauty of Stacked Wood through curated samples; they provide a tactile and visual experience, allowing you to explore the character and color of the material in person. By examining the sample, you can fully appreciate the unique grains, textures, and variations that make stacked wood a captivating choice for your space.

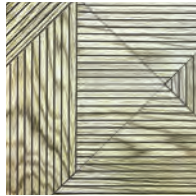

*Due to the nature of the product as a unique and organic material, imperfections and variations in wood grain, cork, and color may vary from samples.*

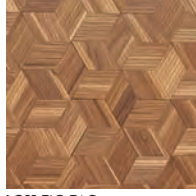
Acoustical Collection			Cork Collection		Cork Collection		Expressive Collection		Generation Collection		Geometry Collection		Maisie Collection		Midnight Collection	
 8000 ACOUSTICAL HEX	 8010 ACOUSTICAL HEX WALNUT	 8004 FLUTED ECO WALNUT	 8100 CORCHO NATURAL	 8202 CORTICA DARK GRAY	 0602 BRITISH COLUMBIA	 0111 ADVENT	 8844 LOZENGE	 2035 SLANT	 4796 ANTIQUED	 3001 BLACK HEX	 3006 BLACK FLUTED					
 8001.2 ACOUSTICAL FLUTED	 8007 ACOUSTICAL FLUTED WALNUT	 8005 FLUTED ECO GREY	 8101 CORCHO WHITE	 8200 CORTICA NATURAL	 0530 MANITOBA	 0429 LOBO	 3315 POLYGON	 2032 CUBED	 2012 JUGLANS	 3003 BLACK AMAZED	 3007 BLACK FLUTED 2"					
 8002 ACOUSTICAL ARBOUR	 8011 ACOUSTICAL ARBOUR WALNUT	 8003 FLUTED ECO OAK	 8102 CORCHO DARK GRAY	 8201 CORTICA WHITE	 1223 ALBERTA	 0929 QUADRI	 4422 RHOMBUS PLAY	 3002 BLACK INTERSECT	 3008 BLACK FLUTED 5"							
 8009 ACOUSTICAL FLUTED WHITE	 8008 ACOUSTICAL FLUTED GREY	 8006 FLUTED ECO WHITE				 2034 VERTEX	 2037 INCLINE	 3004 BLACK INTERSQUARE	 3005 BLACK PEAKS							
						 2033 ZIG ZAG										



# SUMMARY

## Naturele Collection

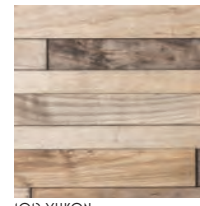

1012 YUKON

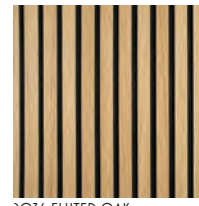

2036 FLUTED OAK

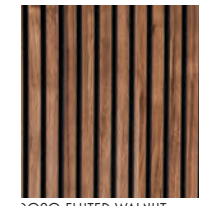

2090 FLUTED WALNUT

## New Era Collection



2031 AMAZED OAK



2095 INTERSQUARE WALNUT

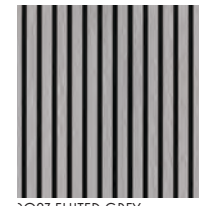

2097 FLUTED GREY

## Paintable Collection



2080 FLUTED PAINTABLE



2086 PEAKS PAINTABLE

## Premier Collection



2001 OAK WEAVE

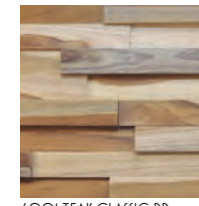

6001 TEAK CLASSIC RP

## Reclaimed Collection



6006 ROOTWOOD DYED



6011 BARKWOOD NATURAL



6005 ROOTWOOD NATURAL

## Satine Collection



1105 PRINCE EDWARD

## Vintage Collection



1231 NATURAL

## Vintage 2 Collection



0903 CELLAR

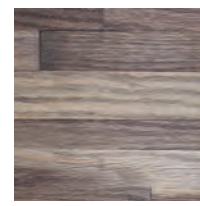

0310 NANAVUT



2038 INTERSECT OAK



2091 INTERSECT WALNUT

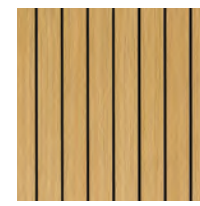

2300 FLUTED 2" OAK UV

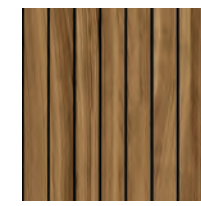

2302 FLUTED 2" WALNUT

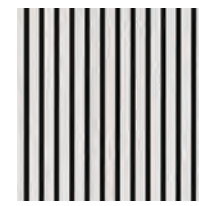

2098 FLUTED WHITE



2081 HEX PAINTABLE



2085 INTERSQUARE PAINTABLE



2002 WALNUT WEAVE



6002 TEAK NATURAL RC



6007 ROOTWOOD BEACH



6012 PROSPERITY NATURAL



6009 HEXACOMB NATURAL

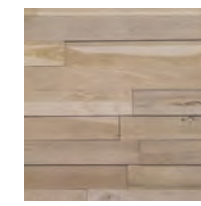

3812 BEACH



0101 HERALDRY



9130 NIAGARA



2093 HEX OAK OIL



2092 HEX WALNUT

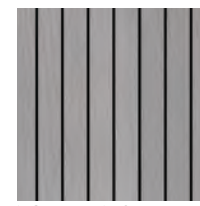

2303 FLUTED 2" GREY

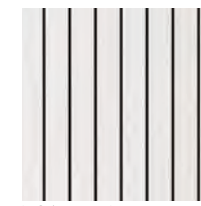

2304 FLUTED 2" WHITE

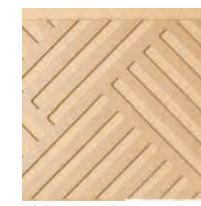

2082 INTERSECT PAINTABLE



2084 AMAZED PAINTABLE



6003 TEAK CLOUD RC



6008 BRANCHWOOD NATURAL

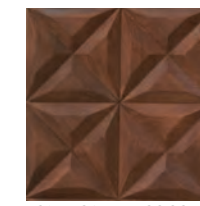

6013 PROSPERITY COCO

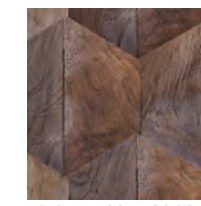

6010 HEXACOMB COCO



0318 BARN

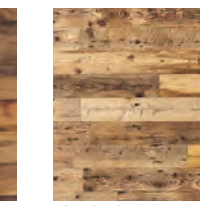

2021 ORIGIN



2094 AMAZED WALNUT



2096 PEAKS WALNUT



2301 FLUTED 2" OAK OIL



2307 FLUTED 5" WALNUT



2087 FLUTED 2" PAINTABLE



2088 FLUTED 5" PAINTABLE



6004 TEAK COCO RC



2590 ANDOVER



2022 WASHED



2310 FLUTED 5" WHITE

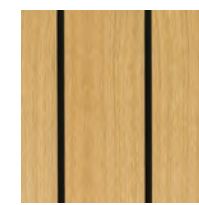

2305 FLUTED 5" OAK UV



2309 FLUTED 5" GREY



2306 FLUTED 5" OAK OIL

Please visit our website for latest details - [stackedwoodwalls.com](http://stackedwoodwalls.com)





Front Cover: 2097 Fluted Grey  
Back Cover: 2037 Incline

PROUDLY DISTRIBUTED BY:



30600 Aurora Road, Suite 110, Solon, OH 44139  
P: 800-358-6332 • designresource-midwest.com



2275 Auto Centre Drive, Glendora, CA 91740  
P: 800-472-7891 • lbiboyd.com



30600 Aurora Road, Suite 110, Solon, OH 44139  
P: 800-362-9930 • fashionadco.com

Please visit [stackedwoodwalls.com](http://stackedwoodwalls.com) to obtain the correct installation instructions per design.



[STACKEDWOODWALLS.COM](http://STACKEDWOODWALLS.COM)

Please contact your area representative for more information or samples.